



Les fortifications de

VAUBAN

inscrites sur la Liste du patrimoine mondial de l'UNESCO



La tour de Tatihou

Après la bataille de La Hougue en 1692, qui voit la destruction de douze vaisseaux incendiés par les Anglais devant Tatihou, l'ingénieur Descombes édifie sous les ordres de Vauban deux tours, l'une sur la presqu'île de Saint-Vaast et l'autre sur l'île Tatihou, accessible à marée basse. Servant à la fois pour l'observation et pour le tir à la mer, ces deux tours tronconiques avec tourelle d'escalier engagée couvraient le seul mouillage abrité entre Le Havre et Saint-Malo. L'île Tatihou, appartenant au Conservatoire du Littoral et gérée par le département de la Manche, est ouverte au public depuis 1992. Dans ce site naturel préservé, accessible par bateau amphibie, le musée maritime propose une offre pédagogique riche et variée: animations, événements, ateliers et expositions permettant d'intéresser un large public.

Échelle 1:125

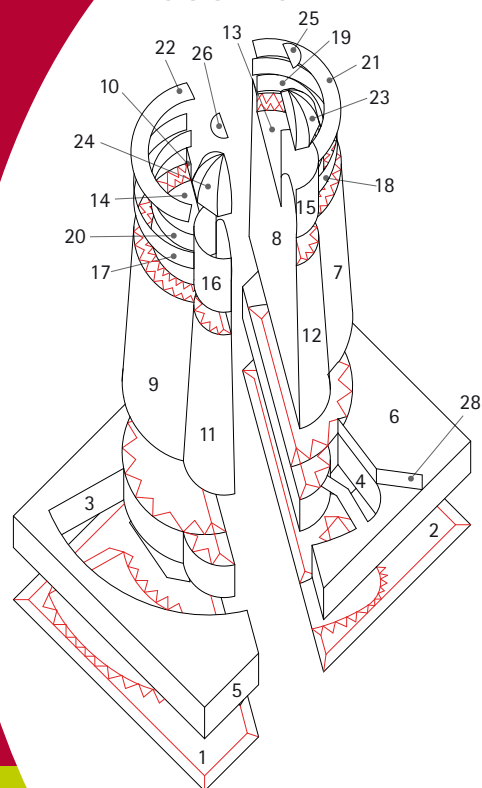

- - - Découpage
- Pliage extérieur
- Pliage intérieur
- 1 Support d'autres pièces

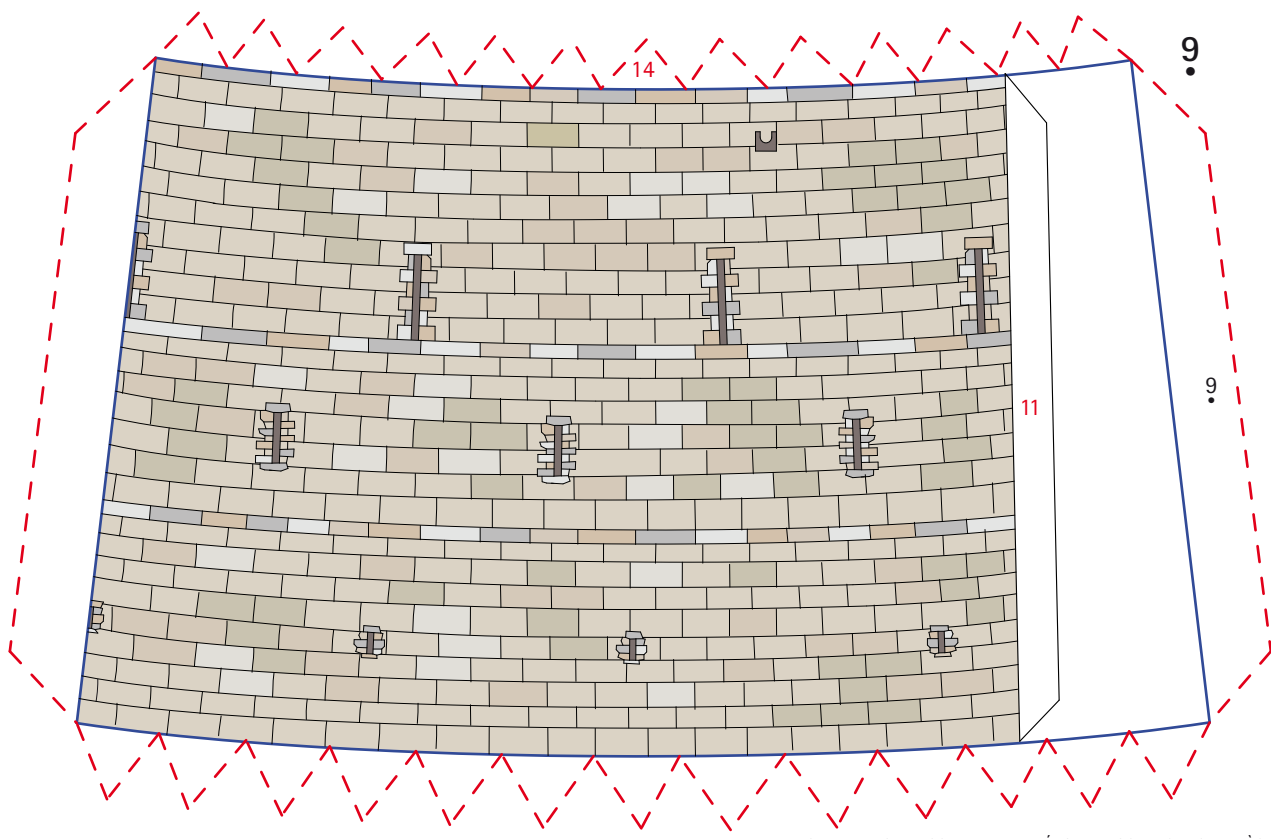
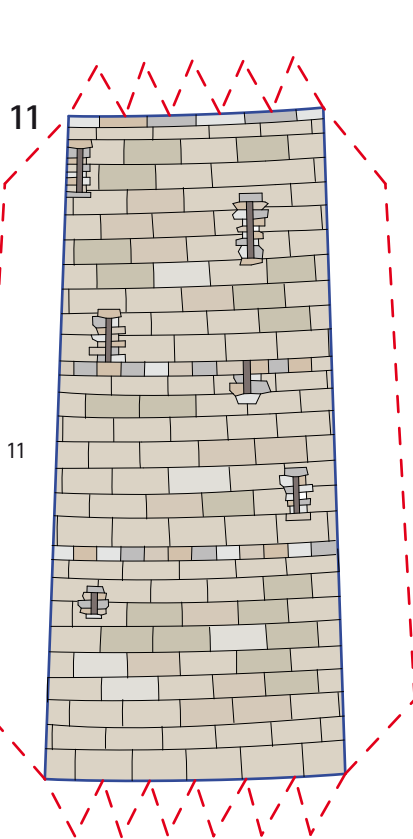
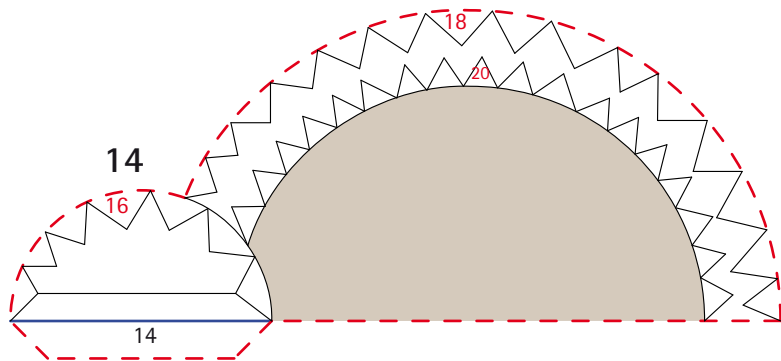
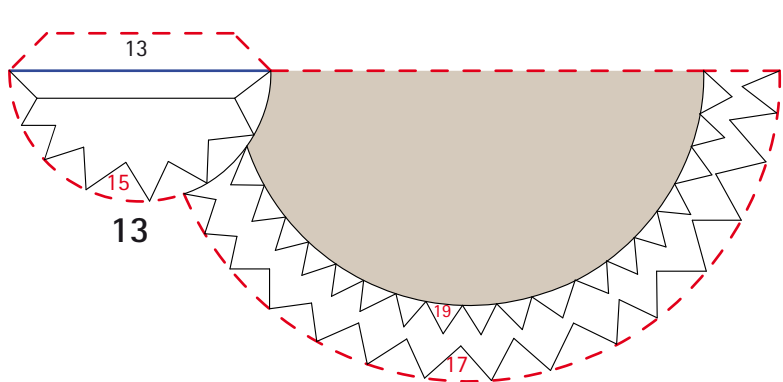
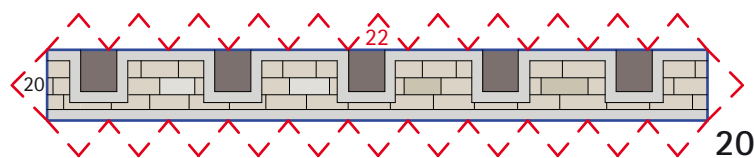
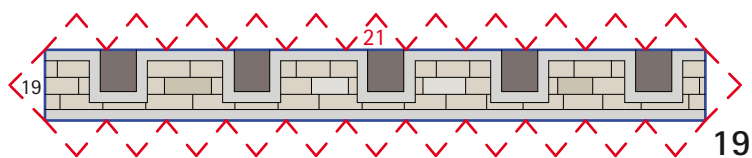

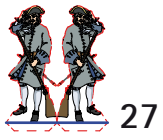

27

8

13

8

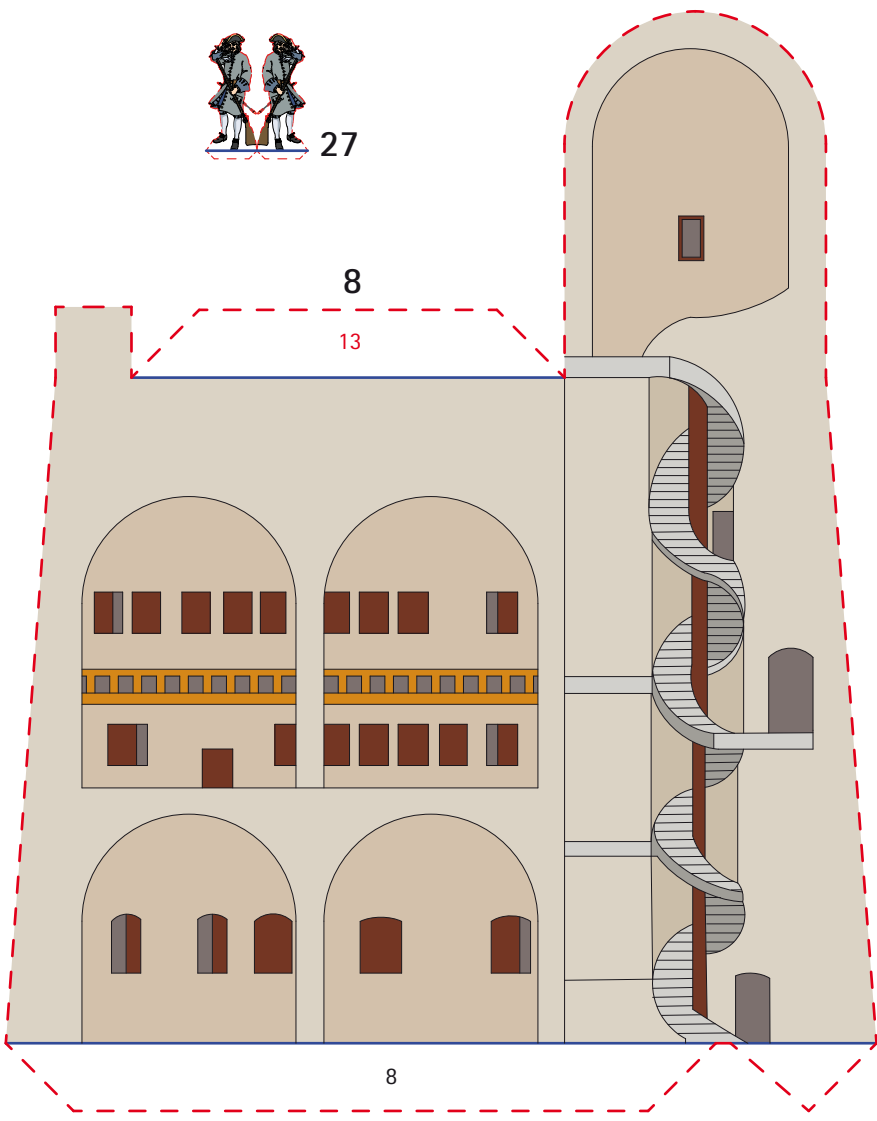

12

12

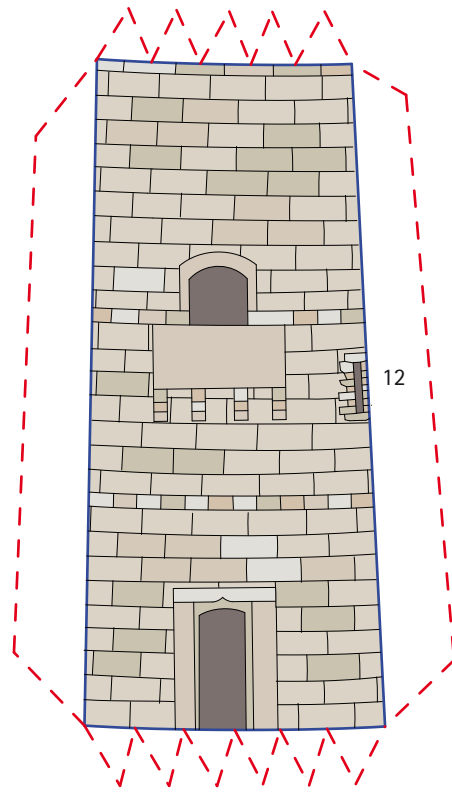

4

4

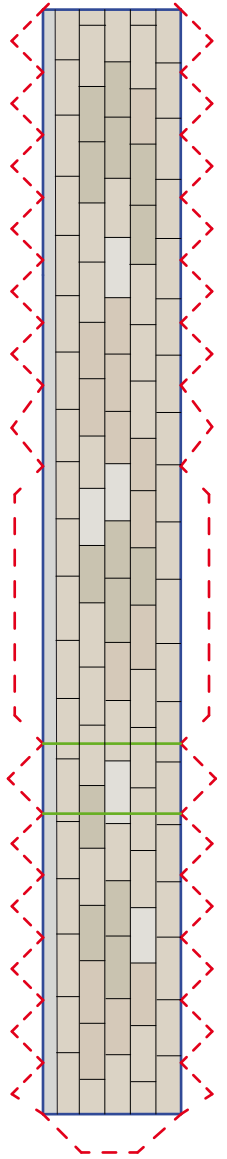

7

7

12

13

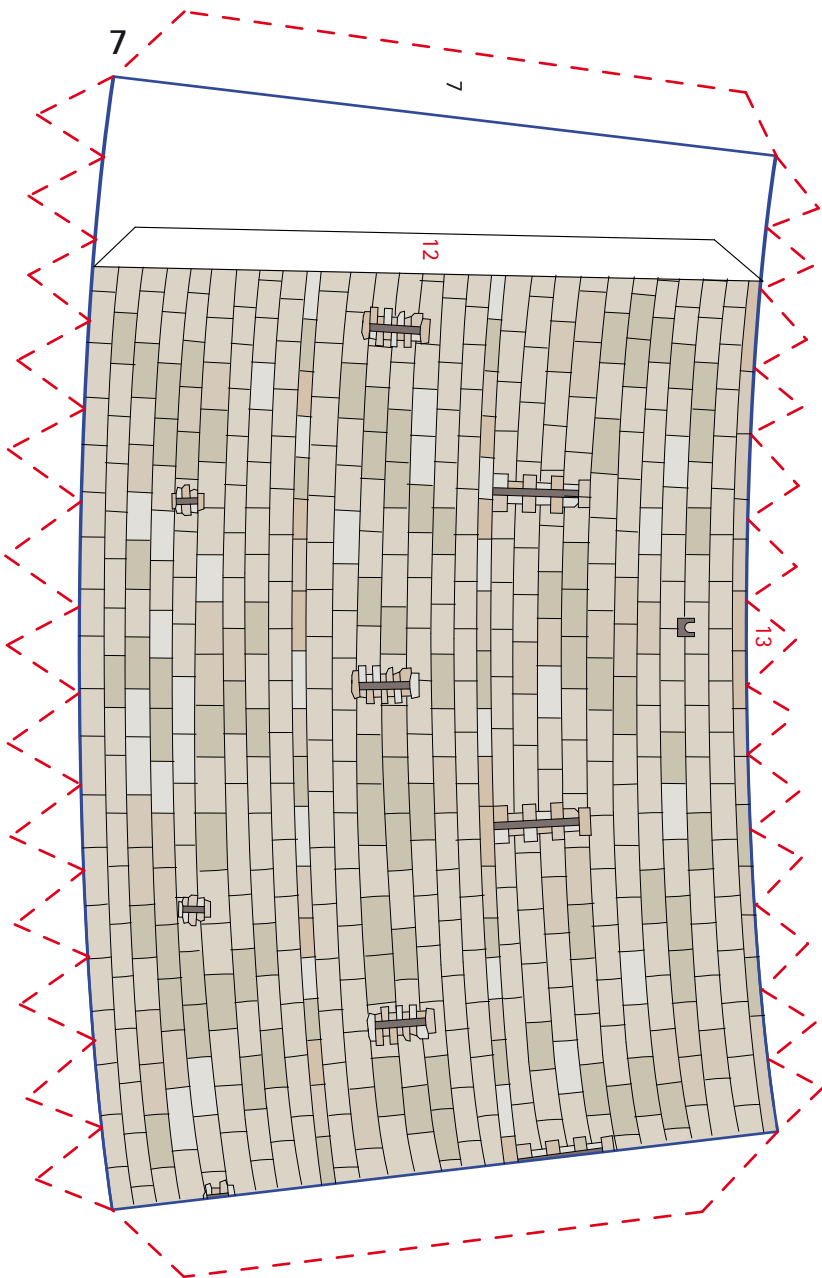

10

14

10

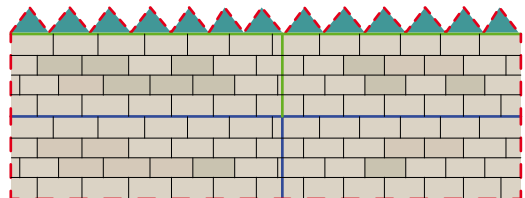
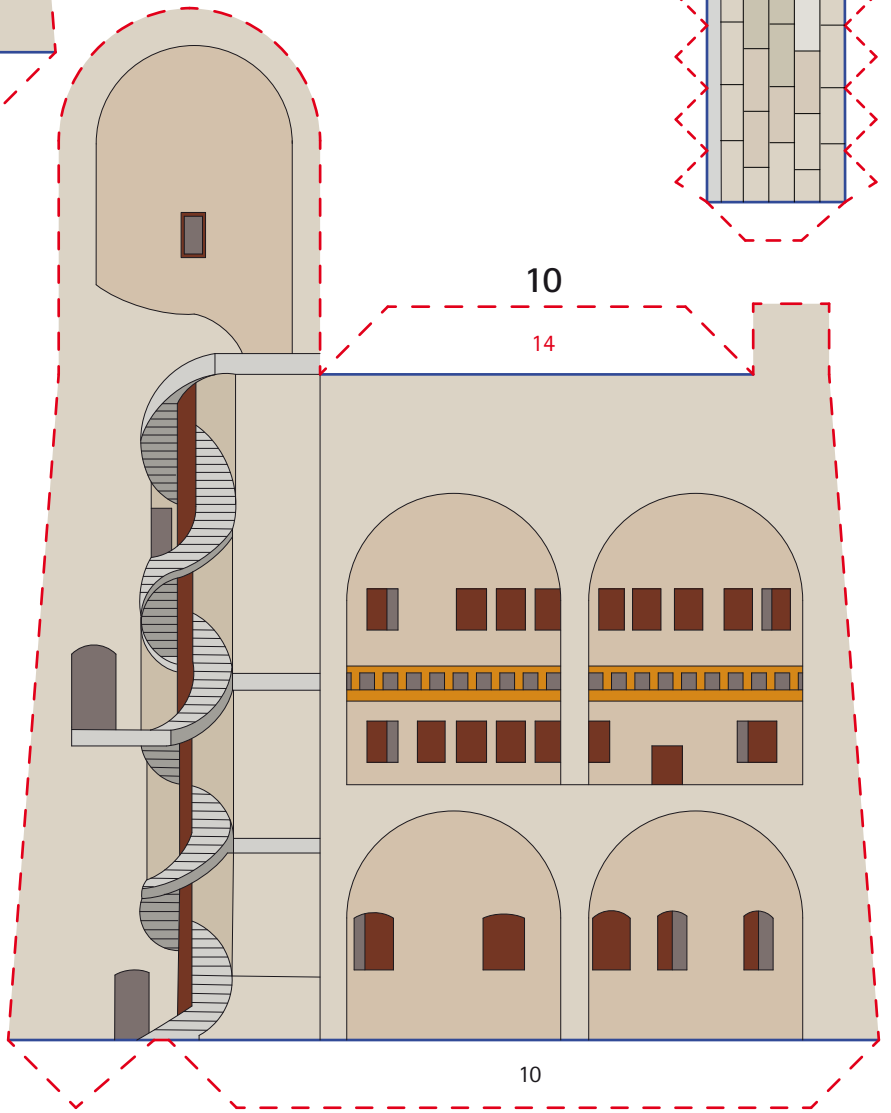

28

